

## Relay Terminal Block (screw type)

### ■ Features

- For driving various loads using PLC output signals
- Easily check operation status and high luminance LED turns on with input signals
- Choose various relays depending on each load voltage or current
  - Easily replace relays using the relay removal lever (1-point relay terminal block)
- 2 mounting methods (DIN rail, screw mount)
- Tight installation and expansion possible with interlocking design (1-point relay terminal block)

※Please refer to 'I/O cable' in the I/O terminal block catalogue.



⚠ Please read "Safety Considerations" in instruction manual before using.



### ■ Ordering Information

<b>AB</b>	<b>S</b>	<b>-</b>	<b>H</b>	<b>16</b>	<b>PA</b>	<b>5</b>	<b>-</b>	<b>N</b>	<b>N</b>																																										
<p>Terminal block</p> <p>Controller</p> <p>Number of relay points</p> <p>Relay type</p> <p>Voltage of relay coil</p> <p>Input logic</p> <p>Varistor installation</p>																																																			
<table border="1"> <tr> <td>N</td> <td>Not installed</td> </tr> <tr> <td>C</td> <td>COM None<sup>※1</sup></td> </tr> <tr> <td>N</td> <td>NPN (COM+)</td> </tr> <tr> <td>P</td> <td>PNP (COM-)</td> </tr> <tr> <td>No-mark</td> <td>24VDC</td> </tr> <tr> <td>5</td> <td>200/220VAC or 220VAC</td> </tr> <tr> <td>6</td> <td>100/110VAC</td> </tr> <tr> <td>TN</td> <td>TAKAMISAWA (Fujitsu) <b>NYP</b></td> </tr> <tr> <td>PA</td> <td>MATSUSHITA (Panasonic) <b>PA</b></td> </tr> <tr> <td>PQ</td> <td>MATSUSHITA (Panasonic) <b>PQ</b></td> </tr> <tr> <td>R6</td> <td>OMRON <b>G6B</b></td> </tr> <tr> <td>PH</td> <td>MATSUSHITA (Panasonic) <b>AHN</b></td> </tr> <tr> <td>R2</td> <td>OMRON <b>G2R</b></td> </tr> <tr> <td>01</td> <td>1</td> </tr> <tr> <td>04</td> <td>4</td> </tr> <tr> <td>16</td> <td>16</td> </tr> <tr> <td>32</td> <td>32</td> </tr> <tr> <td>S</td> <td>Screw</td> </tr> <tr> <td>H</td> <td>Hirose connector</td> </tr> <tr> <td>S</td> <td>Screw</td> </tr> <tr> <td>AB</td> <td>Relay terminal block</td> </tr> </table>										N	Not installed	C	COM None <sup>※1</sup>	N	NPN (COM+)	P	PNP (COM-)	No-mark	24VDC	5	200/220VAC or 220VAC	6	100/110VAC	TN	TAKAMISAWA (Fujitsu) <b>NYP</b>	PA	MATSUSHITA (Panasonic) <b>PA</b>	PQ	MATSUSHITA (Panasonic) <b>PQ</b>	R6	OMRON <b>G6B</b>	PH	MATSUSHITA (Panasonic) <b>AHN</b>	R2	OMRON <b>G2R</b>	01	1	04	4	16	16	32	32	S	Screw	H	Hirose connector	S	Screw	AB	Relay terminal block
N	Not installed																																																		
C	COM None <sup>※1</sup>																																																		
N	NPN (COM+)																																																		
P	PNP (COM-)																																																		
No-mark	24VDC																																																		
5	200/220VAC or 220VAC																																																		
6	100/110VAC																																																		
TN	TAKAMISAWA (Fujitsu) <b>NYP</b>																																																		
PA	MATSUSHITA (Panasonic) <b>PA</b>																																																		
PQ	MATSUSHITA (Panasonic) <b>PQ</b>																																																		
R6	OMRON <b>G6B</b>																																																		
PH	MATSUSHITA (Panasonic) <b>AHN</b>																																																		
R2	OMRON <b>G2R</b>																																																		
01	1																																																		
04	4																																																		
16	16																																																		
32	32																																																		
S	Screw																																																		
H	Hirose connector																																																		
S	Screw																																																		
AB	Relay terminal block																																																		
Item																																																			

※1: It is only for 1-point and 4-point models.

※This ordering information is only for reference. When selecting the model, refer to the specifications of each model.

### ■ Terminal Specifications

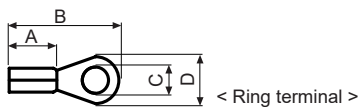
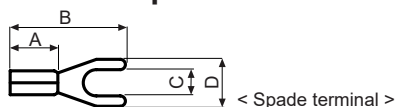

#### ○ Rated load current 2/3A

(unit: mm)

	A	B	C	D	Applicable wire
Spade crimp terminal	≥4.1	≤16.0	≥3.0	≤5.9	AWG 22-16
Ring crimp terminal	≥4.1	≤16.0	≥3.0	≤5.9	(0.30 to 1.25mm <sup>2</sup> )

#### ○ Rated load current 5A, 10A

	A	B	C	D	Applicable wire	
					Rated load current 5A	Rated load current 10A
Spade crimp terminal	≥4.1	≤16.0	≥3.0	≤7.0	AWG 19-14	AWG 17-14
Ring crimp terminal	≥4.1	≤16.0	≥3.0	≤7.0	(0.65 to 2.0mm <sup>2</sup> )	(1.0 to 2.0mm <sup>2</sup> )

※Please use UL certified crimp terminals.

# Relay Terminal Blocks

## Specifications

### Rated load current 2A, 3A

Model	ABS-S01PA-CN ABS-S01TN-CN	ABS-S04PA-CN ABS-S04TN-CN	ABS-H16PA-NN(PN) ABS-H16TN-NN(PN)	ABS-H32PA-NN(PN) ABS-H32TN-NN(PN)	
Power supply	24VDC $\pm$ 10%				
Rated load voltage & current <sup>*1</sup>	250VAC $\sim$ 3A, 30VDC $\equiv$ 3A			250VAC $\sim$ 2A, 30VDC $\equiv$ 2A (2A/1-point, 8A/1COM)	
Current consumption	PA type	$\leq$ 8mA <sup>*2</sup>	$\leq$ 8mA <sup>*2</sup> / $\leq$ 13mA <sup>*3</sup>		
	TN type	$\leq$ 8.5mA <sup>*2</sup>	$\leq$ 8.5mA <sup>*2</sup> / $\leq$ 13.5mA <sup>*3</sup>		
Output type	1a contact relay output				
Applicable relay	PA: APAN3124 [MATSUSHITA (Panasonic)], TN: NYP24W-K [TAKAMISAWA (Fujitsu)]				
No. of relay points	1-point	4-point	16-point	32-point (8-point/1COM)	
No. of connector pins	—		20-pin	40-pin	
Indicator	Operation indicator: Blue LED		Power indicator: Red LED, Operation and disconnection indicator: Blue LED		
Applicable wire	AWG22-16 (0.30 to 1.25mm <sup>2</sup> )				
Insulation resistance	$\geq$ 1,000M $\Omega$ (at 500VDC megger)				
Dielectric strength	Between coil-contact	3,000VAC 50/60Hz for 1 minute			
	Between same contacts	1,000VAC 50/60Hz for 1 minute <sup>*4</sup>			
Vibration	Mechanical	0.75mm amplitude at frequency of 10 to 55 Hz (for 1 min) in each X, Y, Z direction for 2 hours			
	Malfunction	0.75mm amplitude at frequency of 10 to 55 Hz (for 1 min) in each X, Y, Z direction for 10 minute			
Shock	Mechanical	500m/s <sup>2</sup> (approx. 50G) in each X, Y, Z direction for 3 times			
	Malfunction	147m/s <sup>2</sup> (approx. 15G) in each X, Y, Z direction for 3 times			
Environment	Ambient temperature	-15 to 55°C, storage: -25 to 65°C			
	Ambient humidity	35 to 85%RH, storage: 35 to 85%RH			
Material	CASE & BASE: Polyamide 6, TERMINAL PIN: Brass	CASE & BASE: Modified Polyphenylene Oxide, TERMINAL PIN: Brass	CASE: MPPO, BASE: Polyamide 66 (G25%) TERMINAL PIN: Brass		
Tightening torque	0.5 to 0.6 N·m				
Accessories <sup>*5</sup>	—		Jumper bar: 2 (Model: JB-7.62-04)	Jumper bar: 2 (Model: JB-7.62-08) —	
Approval	CE <sup>*6</sup>		CE <sup>*6</sup>	CE <sup>*6</sup>	
Weight <sup>*7</sup>	PA type	Approx. 314.5g (approx. 21.5g) <sup>*8</sup>	Approx. 104g (approx. 68g)	Approx. 307g (approx. 224g)	Approx. 438g (approx. 345g)
	TN type	Approx. 324.5g (approx. 22.2g) <sup>*8</sup>	Approx. 107g (approx. 71g)	Approx. 318g (approx. 235g)	Approx. 463g (approx. 370g)

### Rated load current 5A, 10A

Model	ABS-S01PQ-CN ABS-S01R6-CN	ABS-S01PH-CN	ABS-S01PH6-CN	ABS-S01PH5-CN	ABS-S01R2-CN	ABS-S01R26-CN	ABS-S01R25-CN
Power supply	24VDC $\pm$ 10%	24VDC $\equiv$	100/110VAC $\sim$	220VAC $\sim$	24VDC $\equiv$	100/110VAC $\sim$	200/220VAC $\sim$
Rated load voltage & current <sup>*1</sup>	250VAC $\sim$ 5A, 30VDC $\equiv$ 5A	250VAC $\sim$ 10A, 30VDC $\equiv$ 10A <sup>*1</sup>					
Current consumption <sup>*2</sup>	PQ/R6 type	$\leq$ 20mA	—				
	PH/R2 type	—	$\leq$ 25mA	$\leq$ 15mA	$\leq$ 9mA	$\leq$ 25mA	$\leq$ 15mA
Output type	1a contact relay output	1c contact relay output					
Applicable relay	PQ: PQ1a-24V [MATSUSHITA (Panasonic)] R6: G6B-1174P-FD-US [OMRON]	AHN12024 [MATSUSHITA (Panasonic)]	AHN110X0 [MATSUSHITA (Panasonic)]	AHN110Y2 [MATSUSHITA (Panasonic)]	G2R-1-S24VDC [OMRON]	G2R-1-S100/ (110) VAC [OMRON]	G2R-1-S200/ (220) VAC [OMRON]
No. of relay points	1-point						
Applicable wire	AWG 19 to 14 (0.65 to 2.0mm <sup>2</sup> )	AWG 17 to 14 (1.0 to 2.0mm <sup>2</sup> )					
Insulation resistance	$\geq$ 1,000M $\Omega$ (at 500VDC megger)						
Dielectric strength	Between coil-contact	4,000 VAC 50/60Hz for 1 minute <sup>*4</sup>	5,000VAC 50/60Hz for 1 minute				
	Between same contacts	1,000VAC 50/60Hz for 1 minute <sup>*4</sup>	1,000VAC 50/60Hz for 1 minute				
Vibration	Mechanical	0.75mm amplitude at frequency of 10 to 55 Hz (for 1 min.) in each X, Y, Z direction for 2 hours	1.5mm amplitude at frequency of 10 to 55 Hz (for 1 min) in each X, Y, Z direction for 2 hours				
	Malfunction	0.75mm amplitude at frequency of 10 to 55 Hz (for 1 min.) in each X, Y, Z direction for 10 minute	1.5mm amplitude at frequency of 10 to 55 Hz (for 1 min) in each X, Y, Z direction for 10 minute				
Shock	Mechanical	1,000m/s <sup>2</sup> (approx. 100G) in each X, Y, Z direction for 3 times					
	Malfunction	100m/s <sup>2</sup> (approx. 10G) in each X, Y, Z direction for 3 times					
Environment	Ambient temperature	-15 to 55°C, storage: -25 to 65°C					
	Ambient humidity	35 to 85%RH, storage: 35 to 85%RH					
Material	CASE & BASE: PA6, TERMINAL PIN: Brass	CASE, BASE: PBT, TERMINAL PIN: Brass, Phosphor bronze					
Tightening torque	0.7 to 0.8N·m						
Approval	CE <sup>*6</sup>						
Weight <sup>*8</sup>	PQ: Approx. 430g (approx. 31g), R6: Approx. 416g (approx. 30g)	Approx. 720g (approx. 53g)	Approx. 711g (approx. 52g)	Approx. 715g (approx. 52g)	Approx. 719g (approx. 53g)	Approx. 711g (approx. 52g)	Approx. 712g (approx. 52g)

\*1: Relay contact capacity for resistive load.

\*2: The current consumption including LED current by one relay.

\*3: The current consumption including power LED at \*1.

\*4: R6 type (OMRON relay) is 3,000VAC.

TN type (Fujitsu relay) is 750VAC.

\*5: ABS-H32□□-NN(PN) does not supply jumper bars.

\*6: Except 30VDC of rated load voltage for .

\*7: The weight includes packaging. The weight in parenthesis is for unit only.

\*8: The weight of 1-point relays is per 10 units with packing and the weight of parenthesis is per 1.

\*Environment resistance is rated at no freezing or condensation.

I/O Terminal Blocks

Interface Terminal Blocks

Common Terminal Blocks

Sensor Connector Terminal Blocks

Relay Terminal Blocks

I/O Cables

Connector Type Cables

Open Type Cables

Others

ABS Series

ABL Series

ASL Series

Power Relay

SSR

# ABS Series

## Dimensions

### Rated load current 2/3A

(unit: mm)

#### ABS-S01PA-CN / ABS-S01TN-CN

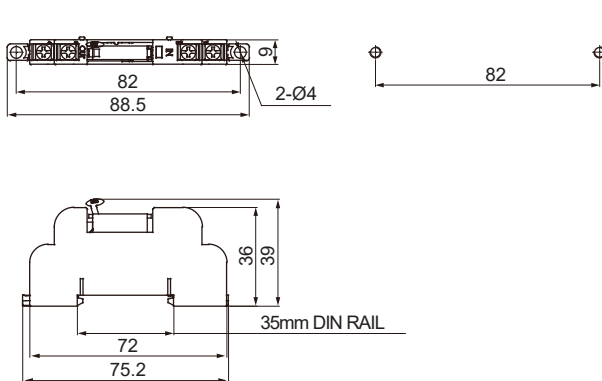

#### ABS-S04PA-CN / ABS-S04TN-CN

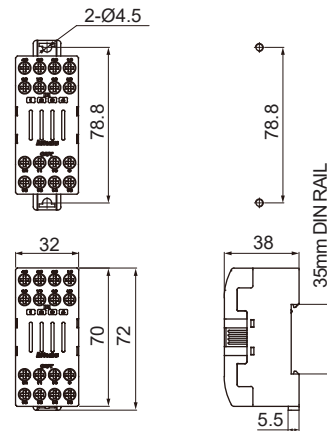

#### ABS-H16PA-□N / ABS-H16TN-□N    ABS-H32PA-□N / ABS-H32TN-□N

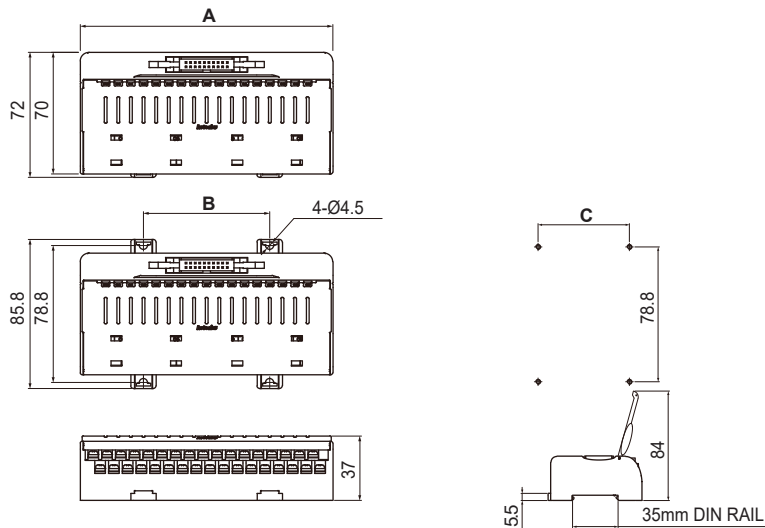

	ABS-H16	ABS-H32
A	140	173
B	70	100
C	70	100

#### Jumper bar (sold separately)

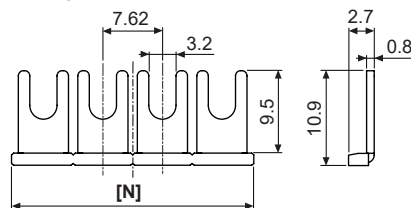

Model	JB-7.62-04	JB-7.62-08
No. of jumper bar pins	4	8
[N] size	29.5	60.0

### Rated load current 5A, 10A

#### ABS-S01PQ-CN / ABS-S01R6-CN

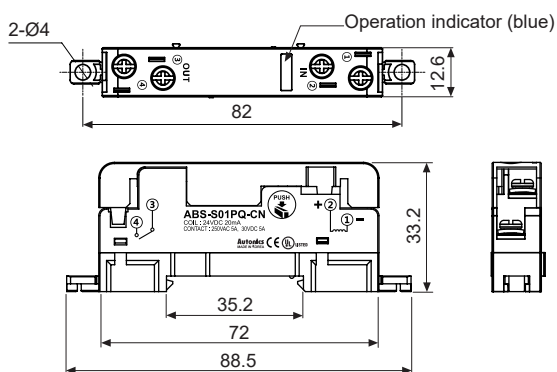

#### ABS-S01PH-□CN / ABS-S01R2-□CN

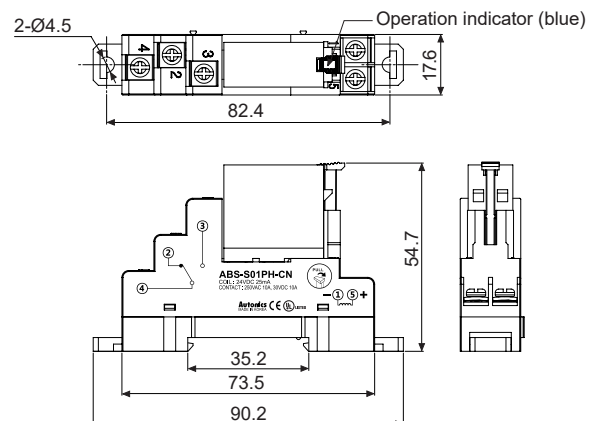

# Relay Terminal Blocks

## Connections

### Rated load current 2/3A

#### • ABS-S01PA-CN / ABS-S01TN-CN

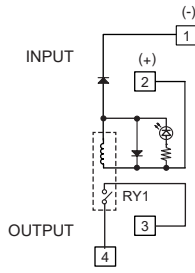

#### • ABS-S04PA-CN / ABS-S04TN-CN

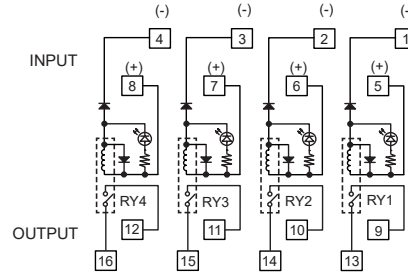

#### • ABS-H16□-NN

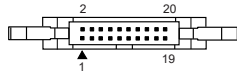

※Hirose connector socket : HIF3BA-20PA-2.54DSA

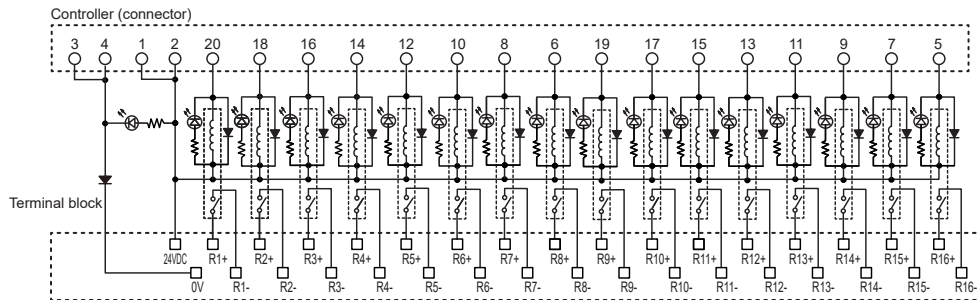

#### • ABS-H16□-PN

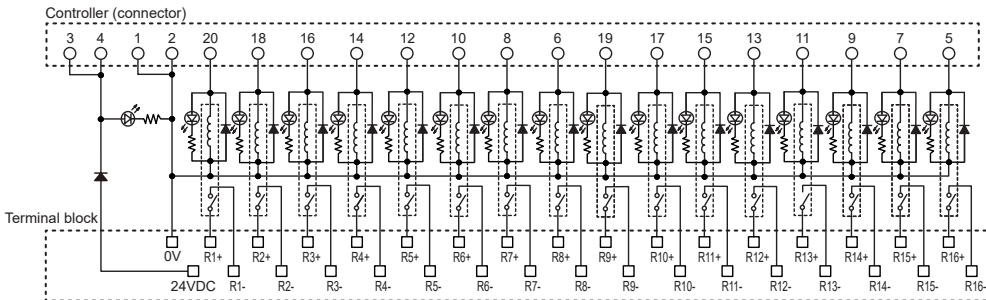

#### • ABS-H32□-NN

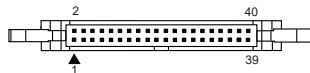

※Hirose connector socket : HIF3BA-40PA-2.54DSA

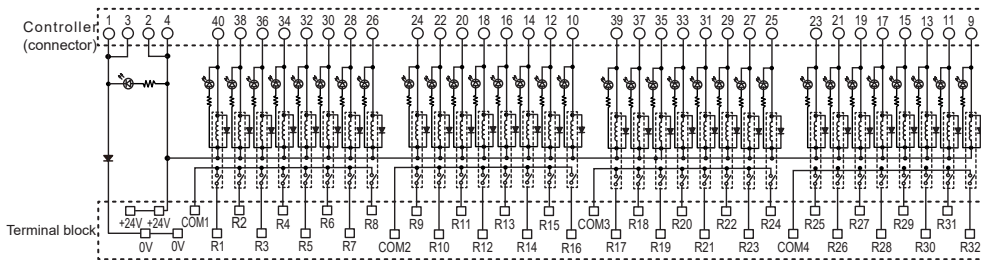

#### • ABS-H32□-PN

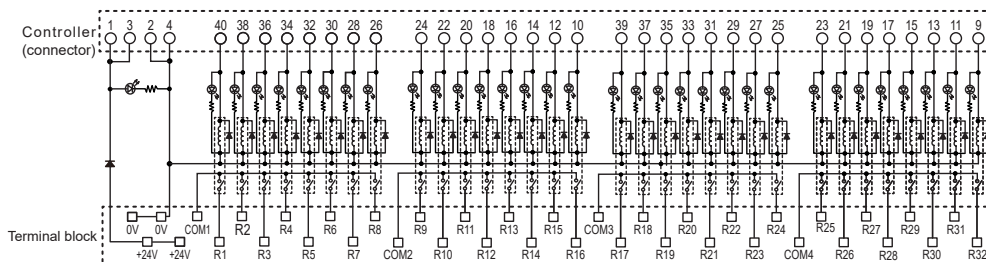

## I/O Terminal Blocks

Interface Terminal Blocks

Common Terminal Blocks

Sensor Connector Terminal Blocks

Relay Terminal Blocks

I/O Cables

Connector Type Cables

Open Type Cables

Others

## ABS Series

ABL Series

ASL Series

Power Relay

SSR

# ABS Series

## ■ Connections

○ Rated load current 5A, 10A

● ABS-S01PQ-CN  
ABS-S01R6-CN

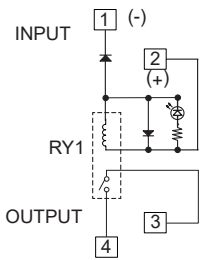

● ABS-S01PH-CN  
ABS-S01R2-CN

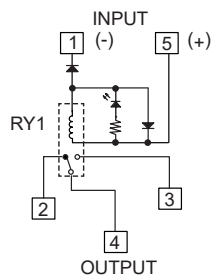

● ABS-S01PH6-CN  
ABS-S01PH5-CN  
ABS-S01R26-CN  
ABS-S01R25-CN

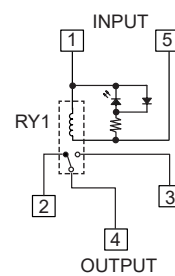

## ■ Replacing Relays

○ Rated load current 2/3A

● ABS-S01PA-CN / ABS-S01TN-CN

- 1) Pull the relay removal lever towards direction ① and the relay will pop up in direction ②.
- 2) Remove the relay and return the relay removal lever to its original position.
- 3) Check the socket position and insert the relay into the socket.

※If pulling the relay removal lever to left or right, the lever may be broken.

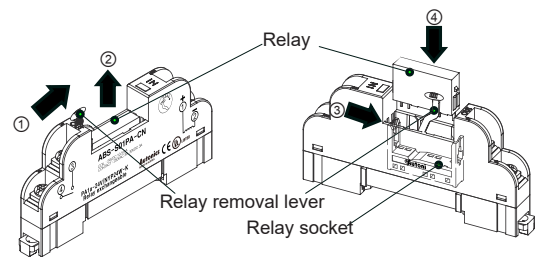

● ABS-S04PA-CN / ABS-S04TN-CN  
● ABS-H16PA-□N / ABS-H16TN-□N  
● ABS-H32PA-□N / ABS-H32TN-□N

• Two way ejector position for relay replacement

< Two way ejector >

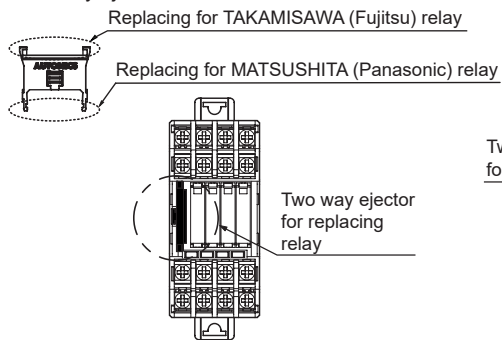

< ABS-S04 >

Two way ejector for replacing relay

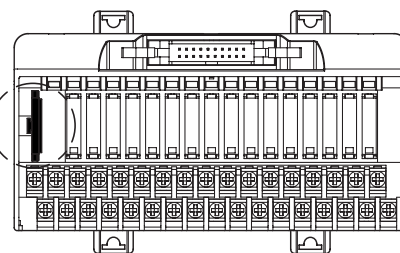

< ABS-H16 / ABS-H32 >

• Removal and insert TAKAMISAWA (Fujitsu) relay

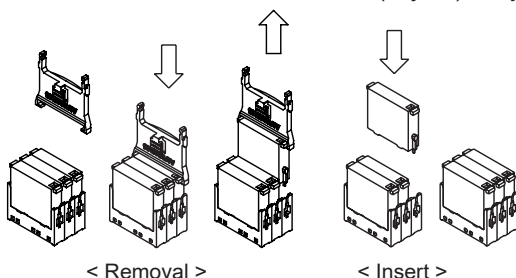

< Removal >

< Insert >

• Removal and insert MATSUSHITA (Panasonic) relay

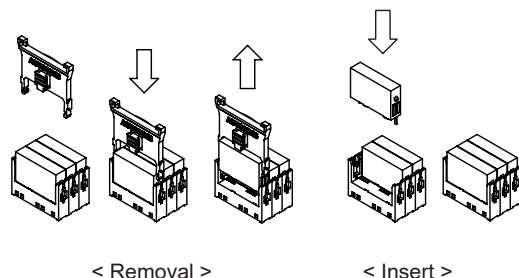

< Removal >

< Insert >

※Relay sockets are compatible with both TAKAMISAWA (Fujitsu) relay, NYP24W-K, and MATSUSHITA (Panasonic) relay, APAN3124.

## ■ Replacing Relays

### ○ Rated load current 5A

#### ● ABS-S01PQ-CN / ABS-S01R6-CN

- 1) Pull the protection cover towards direction ①.
- 2) Press the operation indicator guide in direction ② and remove the relay towards direction ③.
- 3) Insert a new relay into position.

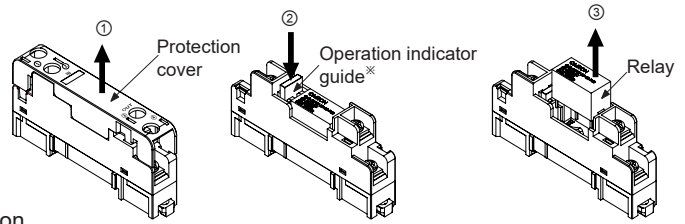

※ Operation indicator guide is used for displaying operation status and removing relays

### ○ Rated load current 10A

#### ● ABS-S01PH□-CN / ABS-S01R2□-CN

- 1) Pull the relay removal lever towards direction ①. Remove the relay towards direction ②.
- 2) Insert a new relay into position.

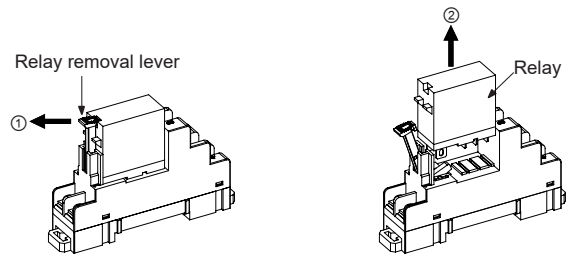

## ■ Installation

※ Each model appearance is different by no. of relay points.

### ○ Mounting and Removal at DIN rail

#### ● Mounting

- 1) Pull the rail lock towards direction ①.
- 2) Attach the DIN rail connection hook onto the DIN rail.
- 3) Push the unit towards direction ②, then push the rail lock in to lock into position.

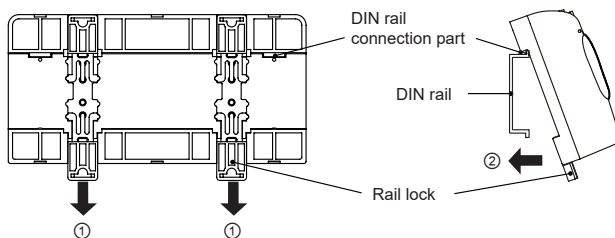

#### ● Removal

- 1) Insert a screwdriver into the rail lock hole and pull it towards direction ①.
- 2) Remove the unit by pulling the unit towards direction ②.

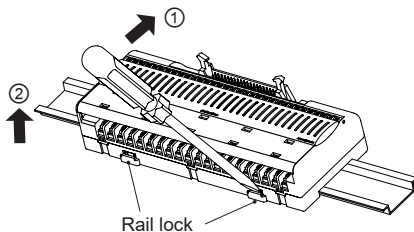

### ○ Mounting with screws

- 1) The unit can be mounted on panels using the rear rail locks.
- 2) Pull the rail locks towards directions ① and ②.
- 3) M4 x 15mm spring washer screws are recommended for installation. When using flat washers, use Ø6mm diameter washers. The tightening torque should be between 7.14 and 10.2kgf-cm (0.7 to 1.0N·m).

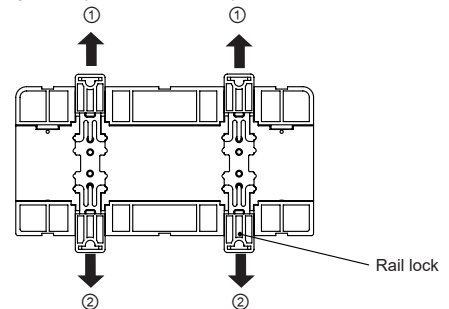

### ○ Connecting multiple units (1-point relay terminal block)

Connect multiple units by locking the socket (凹) and peg (凸) together in direction ①.

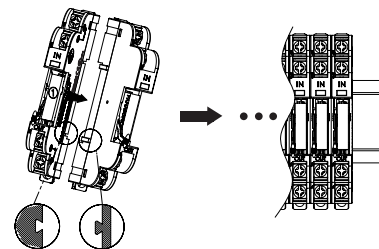

※E.g.

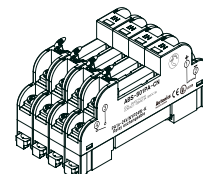

I/O Terminal Blocks

Interface Terminal Blocks

Common Terminal Blocks

Sensor Connector Terminal Blocks

Relay Terminal Blocks

I/O Cables

Connector Type Cables

Open Type Cables

Others

ABS Series

ABL Series

ASL Series

Power Relay

SSR

## ■ Installing Jumper Bars (4, 16, 32-point relay terminal block)

1) Cut the jumper bar to the user's desired length by cutting at the V dent using a nipper.

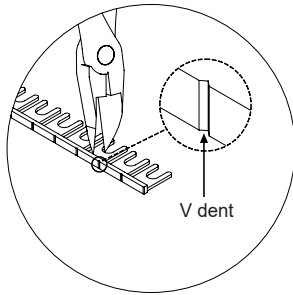

2) Unfasten all the screws of the terminals you wish to commonize.

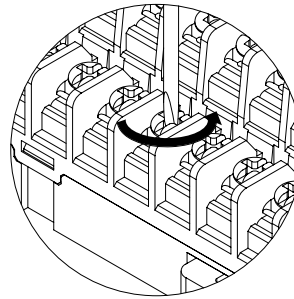

3) Insert the jumper bar below the unfastened screws.

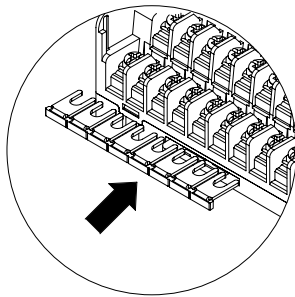

4) Tighten all the screws above the jumper bar.

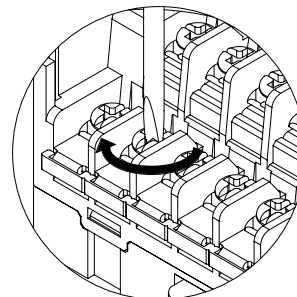

## ■ Cautions during Use

1. Follow instructions in 'Cautions during Use'. Otherwise, it may cause unexpected accidents.
2. Check the polarity of power or COMMON before connecting PLC or other controllers.
3. Do not touch the unit immediately after the load power is supplied or cut.  
It may cause burn by high temperature.
4. 24VDC power supply should be insulated and limited voltage/current or Class 2, SELV power supply device.
5. Wire as short as possible and keep away from high voltage lines or power lines, to prevent surge and inductive noise.  
Do not use near the equipment which generates strong magnetic force or high frequency noise (transceiver, etc.).  
In case installing the product near the equipment which generates strong surge (motor, welding machine, etc.), use diode or varistor to remove surge.
6. This unit may be used in the following environments.
  - ① Indoors(in the environment condition rated in 'Specifications')
  - ② Altitude max. 2,000m
  - ③ Pollution degree 2
  - ④ Installation category II

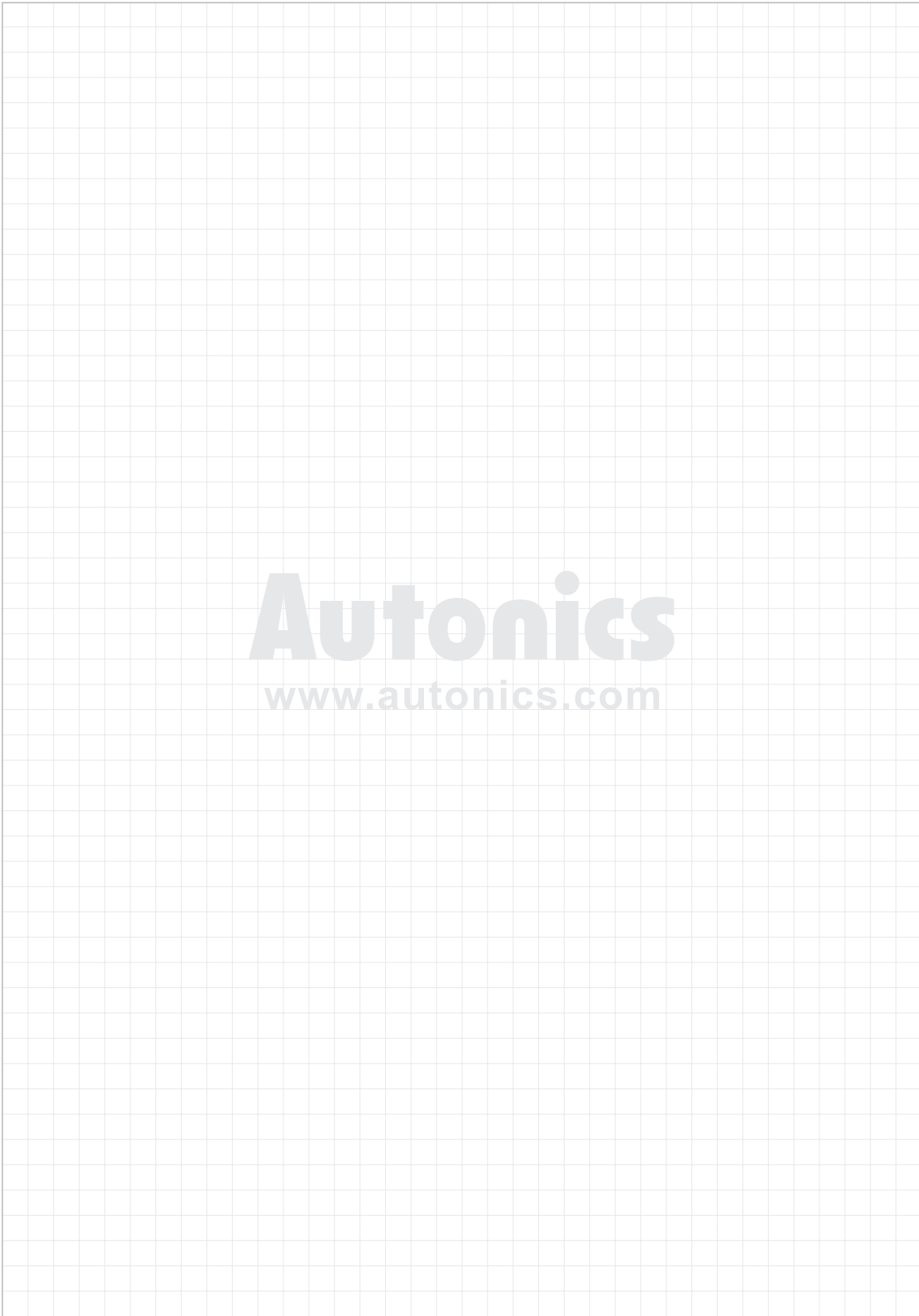

**I/O Terminal Blocks**

- Interface Terminal Blocks
- Common Terminal Blocks
- Sensor Connector Terminal Blocks
- Relay Terminal Blocks

**I/O Cables**

- Connector Type Cables
- Open Type Cables

**Others**

**ABS Series**

- ABL Series
- ASL Series
- Power Relay
- SSR